

Article number: 3901250050200

Description: Worm gear with solid input shaft
VF 250A-50-HS

Measures

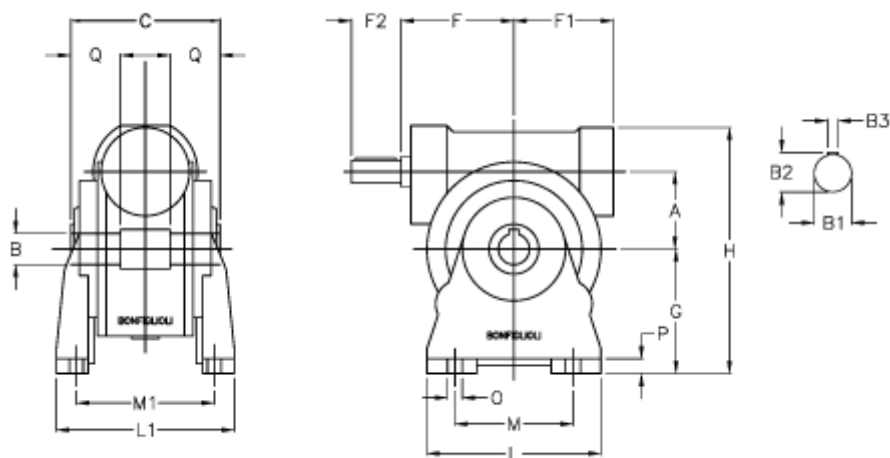

a	= 250.0	F1 = 318	P = 30
B	= 110	g = 380	Q = 85.0
B1 E7	= 55	H = 750	
B2	= 59.0	L = 520	
B3 H9	= 16	L1 = 380	
C	= 320	m = 400	
Description = VF 250A-xx-HS		M1 = 310.0	
F	= 276.0	O = 33.0	